



*Optimal Solutions for the Future*

# T 4000 series



---

**High-Speed,  
High-Productivity  
Tapping Center**

---

**T 4000 series**

T 4000

T 4000L

---

ver. EN 160502 SU

## Product Overview

### Basic information

Basic Structure  
Cutting  
Performance

### Detailed Information

Standard/Optional Specifications  
Applications  
Diagrams  
Machine & NC Unit Specifications

### Customer Support Service



# T 4000 series

Doosan's T Series is a high-speed tapping center that delivers excellent vastly and productivity. The T Series offers even faster acceleration and greater responsiveness, as well as a greatly improved Z axis for increased productivity. Various accessories and peripheral devices are provided as standard feature, creating added value for users.



## Contents

### 02 Product Preview

#### Basic Information

04 Basic Structure

09 Cutting Performance

#### Detailed Information

10 Standard/Optional Specifications

12 Applications

13 Diagrams

15 Machine & NC Unit Specifications

18 Customer Support

Sample

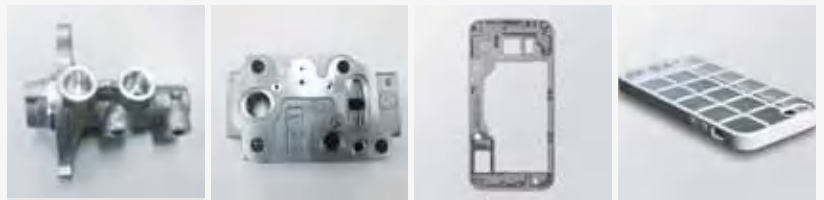

### High Reliability, Free Of Defects

The new servo-driven T Series, equipped with 21 tools as a standard, offers the highest level of reliability due to improved acceleration and deceleration performance resulting from the optimized spindle length.

### NC System with Wide Range of Specifications for Excellent Performance

Fanuc NC eliminate idle time and maximize system productivity.

### Enhanced Stability and User Convenience

User convenience has been improved by reducing the machine and table heights and optimizing the center of gravity.

Basic information

Basic Structure  
Cutting  
Performance

Detailed Information

Standard/Optional Specifications  
Applications  
Diagrams  
Machine & NC Unit Specifications

Customer Support Service

## Basic Structure

Doosan's new tapping center offers improved quality and increased productivity.

### High-speed, High-productivity Tapping Center

The new tapping center delivers best in class productivity by providing superior machining capabilities, a higher feed rate, and a faster tool change time when machining components for the Automotive and IT industries.



Spindle speed **12000 / 24000 r/min**

Automatic Tool Changer **21 ea (Servo)**

Diversified NC unit specification **FANUC CNC**

Description	Unit	T 4000	T 4000L
Travel distance (X / Y / Z)	mm (inch)	520 / 400 / 350 (20.5 / 15.7 / 13.8)	700 / 400 / 350 (27.6 / 15.7 / 13.8)
Table size	mm (inch)	650x400 (25.6x15.7)	850x400 (33.5x15.7)
Load capacity	kg (lb)	300 (661.4)	
Spindle speed	r/min	12000 (24000)	
TSC		<b>option</b>	
No. of tool stations	ea	21	
Rapid traverse	m/min	56	56*
NC specification		DOOSAN FANUC i series	DOOSAN FANUC i series FANUC 31i

\* 48m/min applies to F-31i NC

### Reliability Enhanced with a High-rigidity Structural Design

Improved structural design and increased rigidity, realized through FEM analysis, guarantees a stable machining platform.

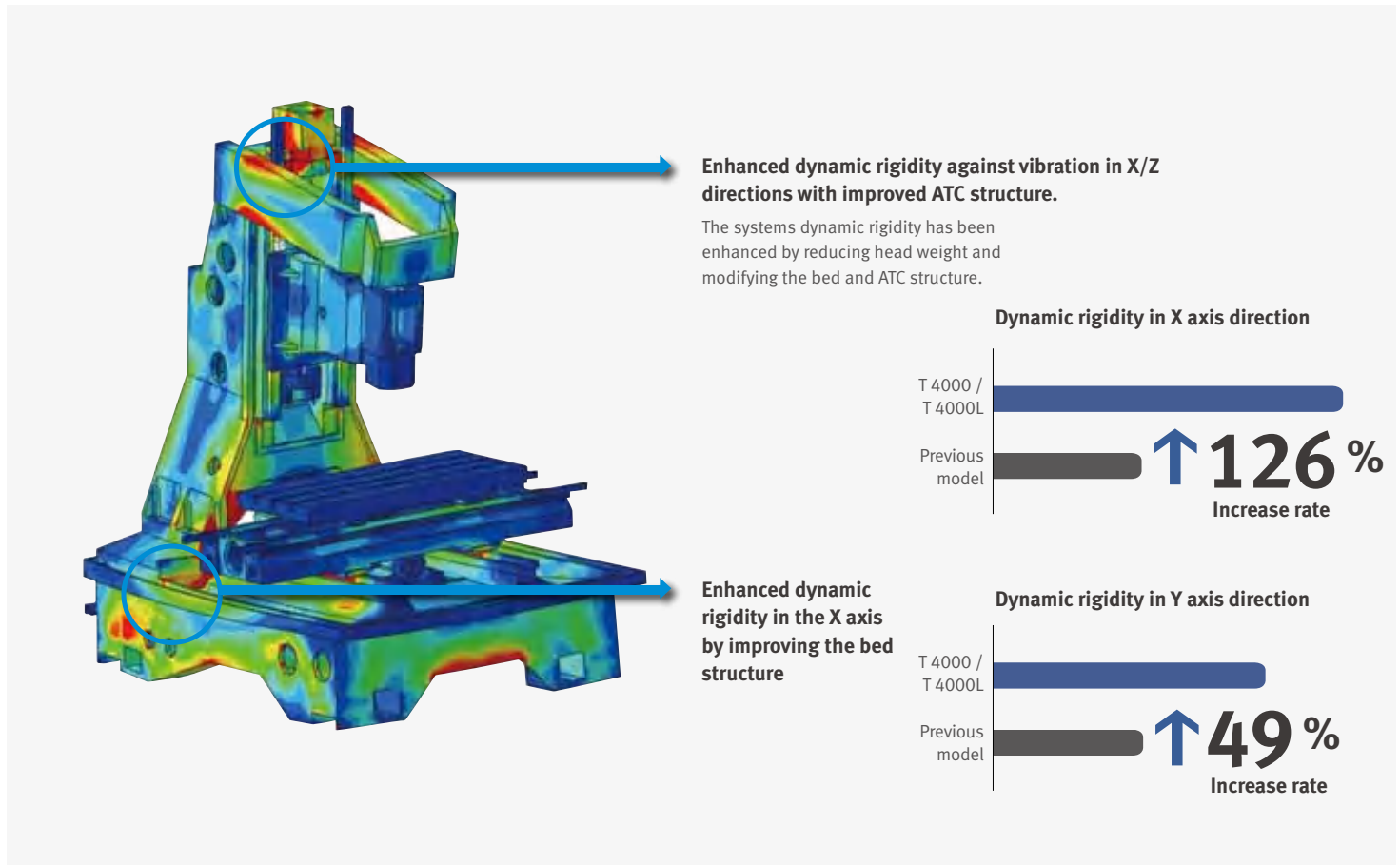

### Optimal Design for the User Environment

The machine's compact design delivers greater user convenience and requires minimal floor space.

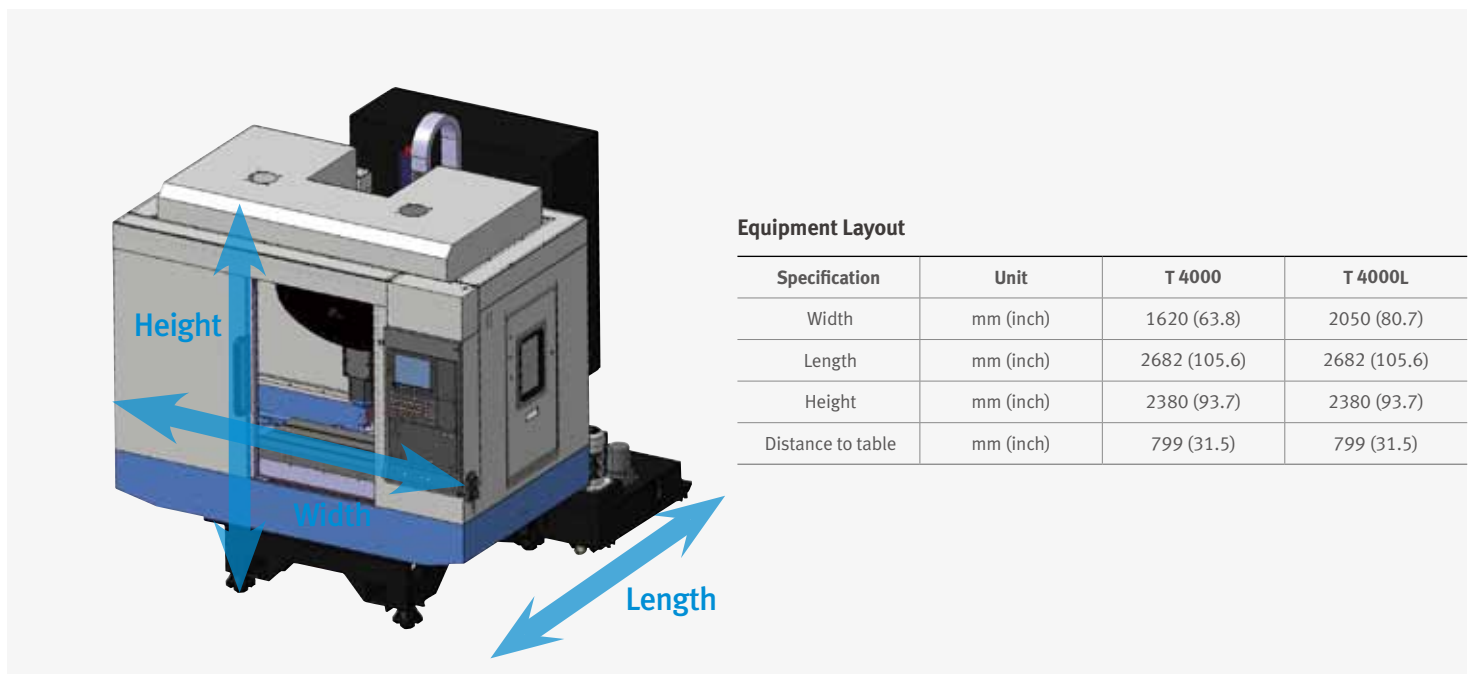



## Spindle & NC Unit Specifications

The newly designed, direct-coupled spindle offers greater productivity coupled with excellent reliability and rapid acceleration/ deceleration.

### New, High-Precision Spindle

The spindle length has been minimized to reduce the time required for acceleration/ deceleration and idle time, resulting in greater productivity and reduced vibration and noise.



### Spindle Thermal Error Compensation System (standard)

Thermal error of the spindle is calculated with the spindle temperature feedback and automatically compensated to maintain the highest level of work accuracy.

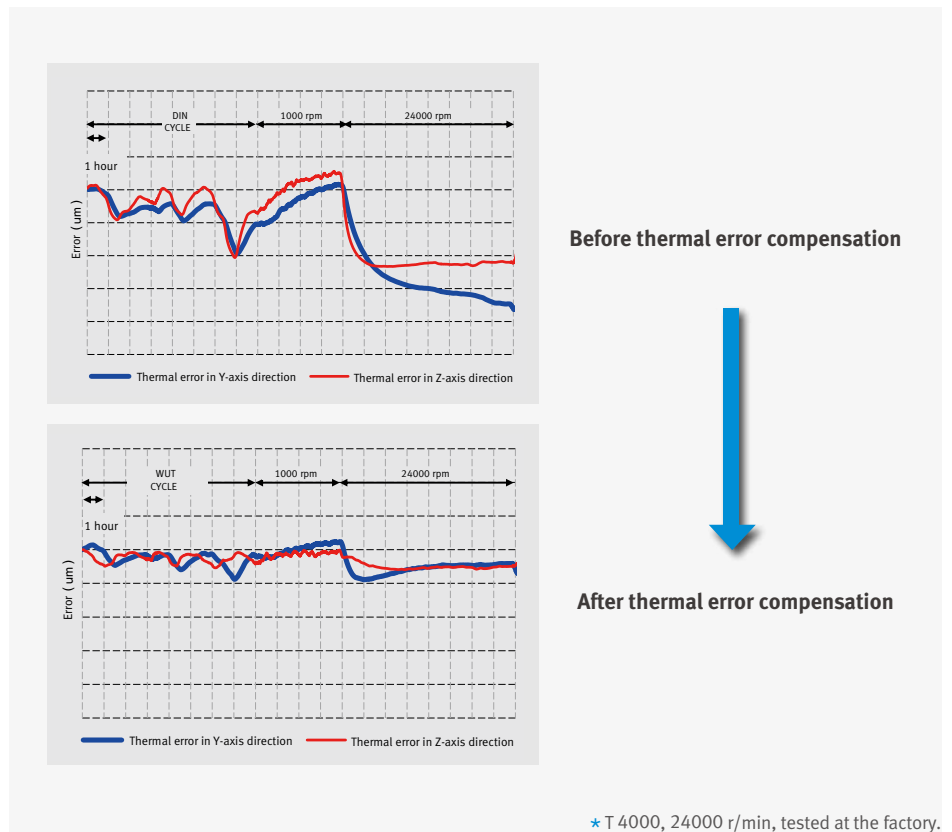

## DOOSAN-FANUC i series

Power and torque of the spindle motor have increased beyond the levels of previous models to deliver more powerful machining.

### Improved Spindle Motor Performance

Spindle	Unit	Previous model	T series
Power	kW (Hp)	5.5 (7.4)	13 (17.4)
Torque	N·m (ft·lbs)	35 (25.8)	83 (61.3)

### Maximize productivity

Specification	Unit	Previous model	T series
Spindle Acceleration/Deceleration	sec	1.04	0.67
Tool-to-Tool	sec	1.48	1.36
Chip-to-Chip	sec	2.4	1.8

### Cycle Time

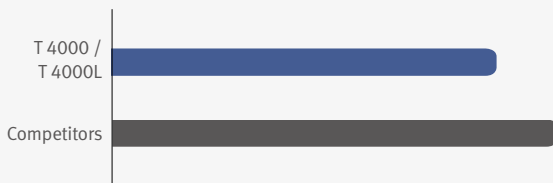

Cycle Time reduced by  
**17%**  
than competitors



IT parts

## FANUC 31i

The FANUC 31i is designed to satisfy users' demands for higher machining accuracy and ultra-fine cutting.

Description	Unit	FANUC 31i
Rapid traverse	m/min	48

### Cycle Time



Cycle Time reduced by  
**15%**  
than previous models

Previous model



Fanuc 31i



Basic information

Basic Structure  
Cutting  
Performance

Detailed Information

Standard/Optional Specifications  
Applications  
Diagrams  
Machine & NC Unit Specifications

Customer Support Service

## Magazine

Machine reliability has been improved with the new servo magazine, while productivity has been enhanced by reducing the tool change time.

### Tool Magazine

The servo-motor driven position control system has passed the two-million-cycles test, proving its excellent reliability and durability.



Servo tool magazine

**21 ea**

Specifications	Max. tool diameter (mm (inch))		Max. tool length (mm(inch))	Max. tool weight (kg (lb))
	Continuous	Adjacent pots empty		
21 tools	80 (3.1)	150 (5.9)	240 (9.4)	2.8 (6.2)

The new T Series is equipped with a 21 tool servo-driven magazine, replacing the 14-tool magazine of previous models. The new drive system is enclosed for greater oil resistance.

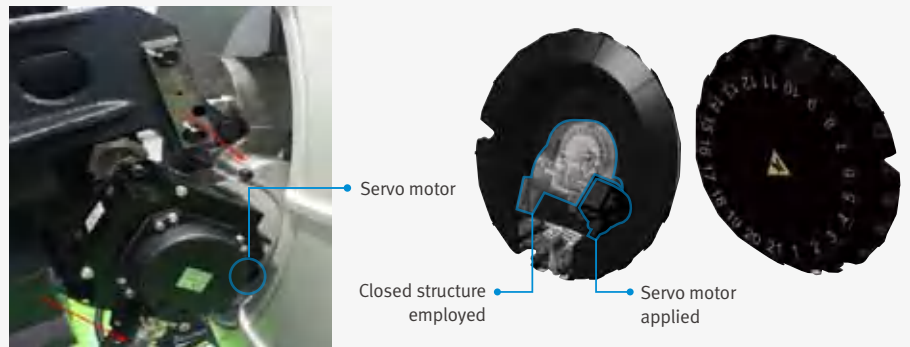

### Simultaneous operation control

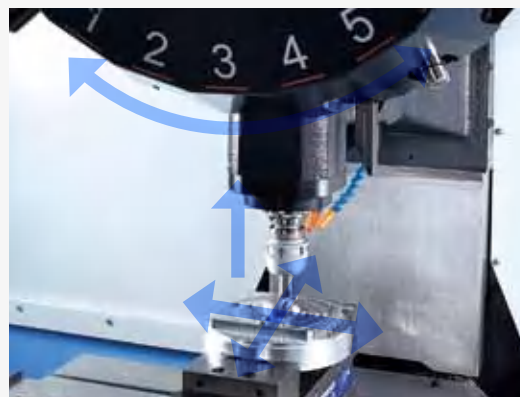

The T Series supports simultaneous X/Y-axis travel during tool change (G100, FANUC), and the axes can be positioned at the next cutting point to minimize idle time.





## Cutting Performance

Multi-functionality including end milling, face milling, drilling, tapping, etc., enhanced machining performance and minimized work setting.

## Powerful Cutting

Tap			Face mill (Ø63 mm (2.5 inch) Face mill)				
	Tool Diameter (mm (inch)) X Pitch (mm (inch))				Chip Removal Rate (cm <sup>3</sup> /min) X Spindle Speed (r/min) X Feedrate (mm/min) X Cutting Depth (mm (inch))		
	SM45C	GC25	AL6061		SM45C	GC25	AL6061
DOOSAN FANUC i series (12000 r/min)	M20 (0.8) X 2.5 (0.1)	M24 (0.9) X 3.0 (0.1)	M30 (1.2) X 3.5 (0.1)	DOOSAN FANUC i series (12000 r/min)	208 X 1500 X 2600 X 2.0 (0.1)	320 X 1500 X 4000 X 2.0(0.1)	684 X 1500 X 5700 X 3.0 (0.1)

\* The results, indicated in this catalogue are provides as example. They may not be obtained due to differences in cutting conditions and environmental conditions during measurement.

## Spindle Power – Torque Diagram

### DOOSAN Fanuc i series

Max. spindle speed : 12000 r/min  
 Spindle Motor : 13 / 7.5 / 5.5 / 3.7 kW  
 (17.4 / 10.1 / 7.4 / 5.0 Hp)

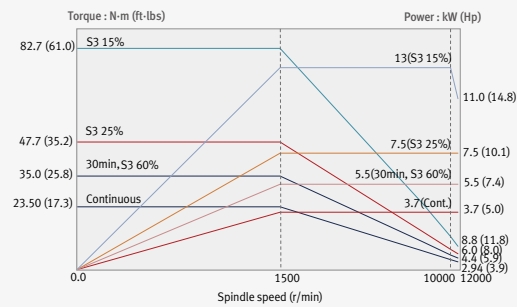

### Fanuc 31i DOOSAN FANUC i series option

Max. spindle speed : 24000 r/min  
 Spindle Motor : 3.7 / 2.2 / 1.1 kW  
 (5.0 / 3.0 / 1.5 Hp)

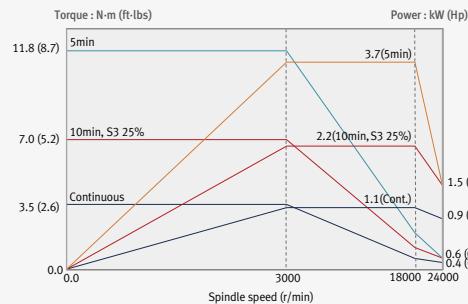

### Fanuc 31i option

Max. spindle speed : 12000 r/min  
 Spindle Motor : 11 / 7.5 / 5.5 / 3.7 kW  
 (14.8 / 10.1 / 7.4 / 5.0 Hp)

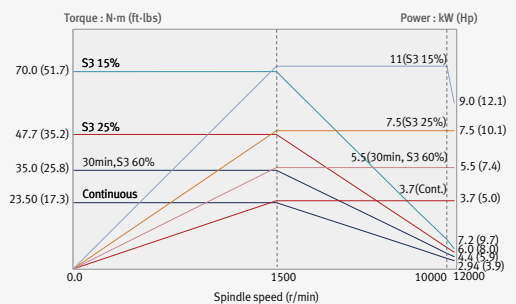

Product Overview

Basic information

Basic Structure  
Cutting  
Performance

Detailed Information

Standard/Optional Specifications  
Applications  
Diagrams  
Machine & NC Unit Specifications

Customer Support Service



Standard/Optional Specifications

Diverse optional devices and features available to meet specific customer requirements.

● Standard ○ Optional X N/A

NO.	Description	Features	F-0i	F-31i
1	Spindle	12000 r/min	●	○
2		24000 r/min	○	●
3	Spindle motor power	12000_5.5/3.7 kW (7.4/5.0 Hp)	●	○
4		12000_15/5.5 kW (20.1/7.4 Hp)	X	X
5		24000_3.7/1.1 kW (5.0/1.5 Hp)	○	●
6	TSC	NONE	●	●
7		1.5 kW (2.0 Hp)_2.0 MPa	○	○
8	LCD size	8.4 inches	●	X
9		10.4 inches	○	●
10		12.1 inches	X	X
11	Tool shank type	BIG PLUS BT30	●	●
12		HSK 63A	X	X
13	Tool magazine	21 tools	●	●
14	Raised column	150mm (5.9 inch)	○	○
15	Hydraulic fixture interface	A/B LINE_1 PAIR	○	○
16		A/B LINE_2 PAIR	○	○
17	Coolant	FLOOD (0.15 MPA)	●	●
18		Flushing	●	●
19		Shower	○	○
20		Coolant gun	○	○
21	OIL SKIMMER	Belt type	○	○
22	AIR	Air blower	○	○
23		Air gun	○	○
24		Spindle air curtain	●	●
25	Chip Conveyor	Chip pan	●	●
26		Hinged type	○	○
27		Magnetic scrapper type	○	○
28	Chip bucket	Forklift or rotation	○	○
29	Automatic front door	Automatic front door	○	○
30	Mist collector		○	○
31	Machine cover type	Top cover	●	●
32	Auto tool length measuring device	TS27R_RENISHAW	○	○
33	Auto tool damage detection device	Needle swing type	○	○
34		Omron limit switch type	○	○
35	Data server	DATA SERVER_1GB	○	○
36	Auto power cut-off		○	○
37	Test bar	Test bar gauge	○	○
38	Signal tower	System condition indicator	●	●

## Diverse Options

### 4-axis Auxiliary device Interface/Hydraulic & Pneumatic Jig Line

- 4-axis Auxiliary device Interface
- Hydraulic/pneumatic jig line

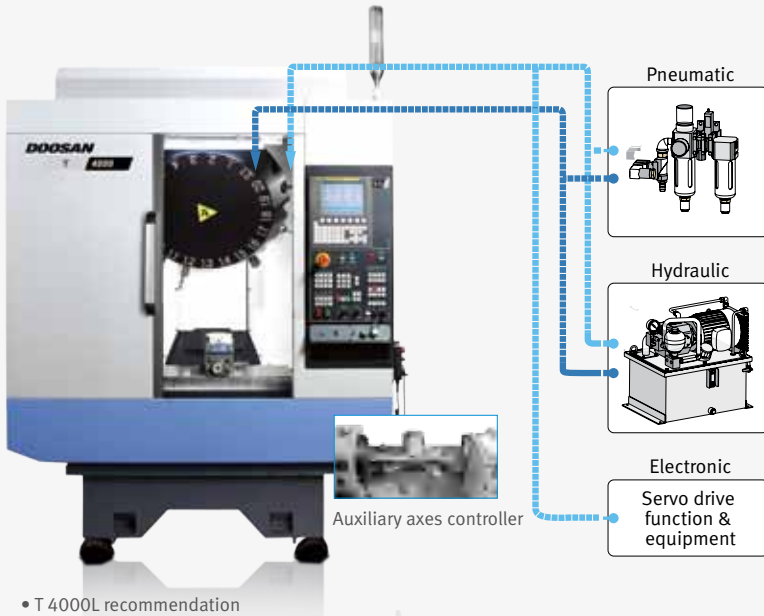

### Checklist for hydraulic/pneumatic lines for work clamping

Hydraulic/pneumatic line for jig

- Hydraulic line  P/T  A/B  
 Pneumatic line  P/T  A/B

Hydraulic unit

- Supplier :  End user  
 Doosan Infracore

- Hydraulic unit  
 24 L/min / 4.4 MPA

- Customer requirements  
 \_\_\_\_\_ L/min at \_\_\_\_\_ MPA

Number of jig ports

- 1 pair (2-PT 1/4" port)  
 2 pair (4-PT 3/8" port)  
 3 pair (6-PT 1/4" port)

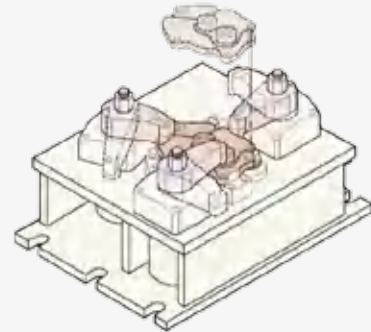

• Please contact us for further detailed specifications.



Through-spindle coolant system

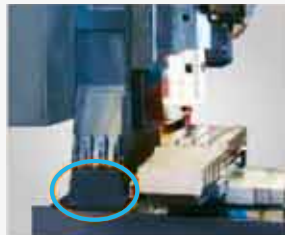

Raised column(150mm)



Auto Door



Chip Conveyor



Minimum Quantity Lubrication



Oil Skimmer



Chip box for fine chip disposal

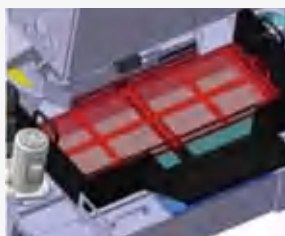

Auto Tool Measurement Device

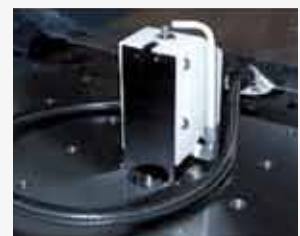



Basic information

- Basic Structure
- Cutting
- Performance

Detailed Information

- Standard/Optional Specifications
- Applications
- Diagrams
- Machine & NC Unit Specifications

Customer Support Service



User-Friendly Operation Panel

The operation panels are integrated, and customer-tailored function switches ensure convenient system operation.

Clamping device lock/unlock button, counter, timer and other special optional buttons are also available.

Buttons are separated by partitions to prevent erroneous operation.

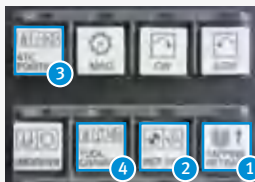

Convenience Functions (Hot Keys)

Frequently used functions can be accessed and used quickly and easily by clicking the hot key buttons.

- 1 Tapping retract function: A function readily releases tool by reverse rotating the spindle in manual mode when the tool is caught due to a power failure, emergency stop or NC reset.
- 2 One-touch zero return function: Pressing in manual mode returns the z axis to the primary zero point.
- 3 ATC position return function: Pressing in manual mode returns the z axis to the secondary zero point, enabling tool magazine rotation.
- 4 Tool change function: Load and auto-exchange an adjacent tool [Current Tool No. +1] in manual mode.

PCMCIA Card

The PCMCIA card enables uploading and downloading of the NC program, NC parameters, tool information, ladder programs, and also supports DNC operation.

USB Port

The USB memory stick enables uploading and downloading of the NC program, NC parameters, tool information and ladder programs. (DNC operation is not supported.)



Convenient Fanuc Control

Variable workload control

Instructing M-code equivalent to the weight of the work automatically selects a table transfer pattern appropriate for the weight to be processed.

FANUC

	M-code	M384	M380	M381
T 4000	Material weight	0 ~ 130 kg	130 ~ 190 kg	190 ~ 300 kg
T 4000L	Material weight	0 ~ 130 kg	130 ~ 190 kg	190 ~ 300 kg

AICC

Higher cutting and feed spindle can be accompanied with unwanted machining error due to high acceleration and deceleration. This function serves to minimize contour deviation of work by controlling servo motor based on block ahead-reading.

DOOSAN Fanuc i series :

AIAPC 20 Block

AICC 40 Block option AICC II 200 Block option

Fanuc 31i :

AICC II 200 Block

AICC II 600 Block option AICC II 1000 Block option

## Dimensions

### T 4000

Unit : mm (inch)

Top View

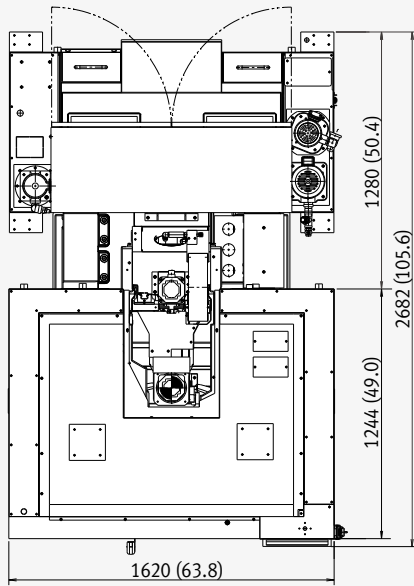

Front View

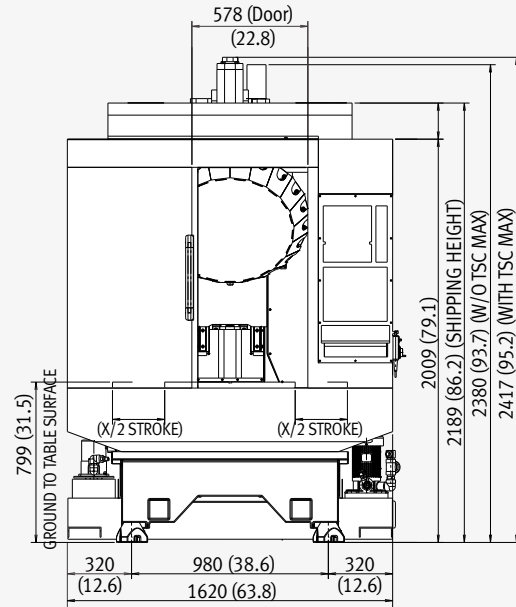

### T 4000L

Unit : mm (inch)

Top View

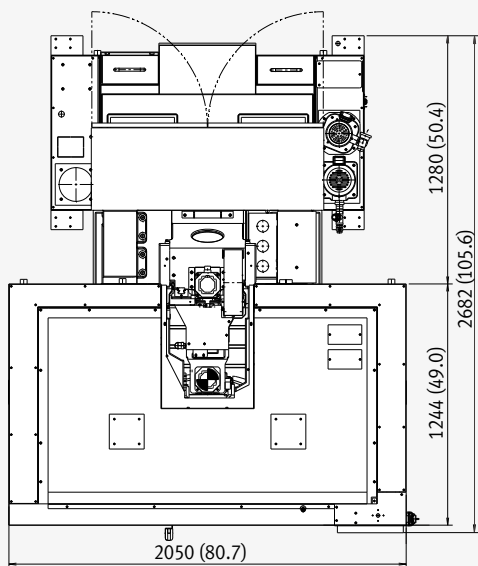

Front View

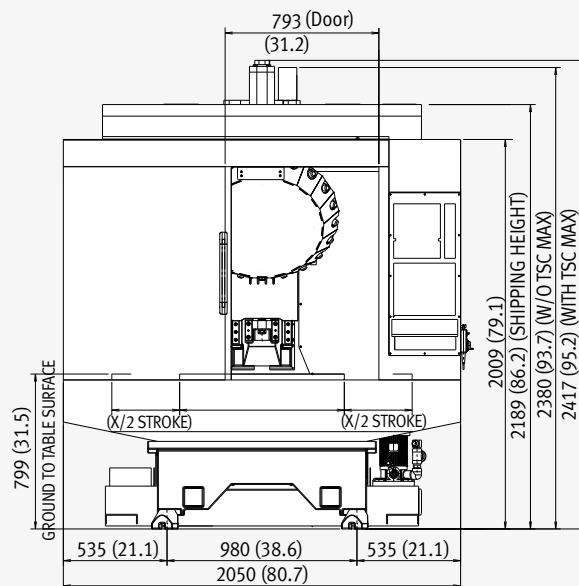



Table

Basic information

Basic Structure  
Cutting  
Performance

Detailed Information

Standard/Optional Specifications  
Applications  
Diagrams  
Machine & NC Unit Specifications

Customer Support Service

T 4000

Unit : mm (inch)

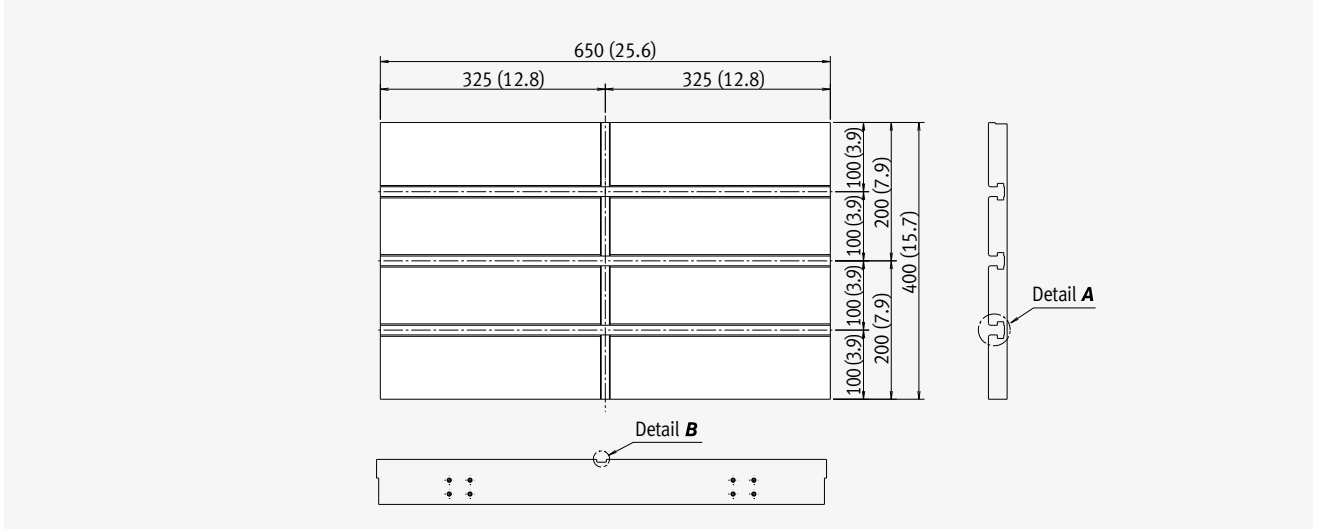

T 4000L

Unit : mm (inch)

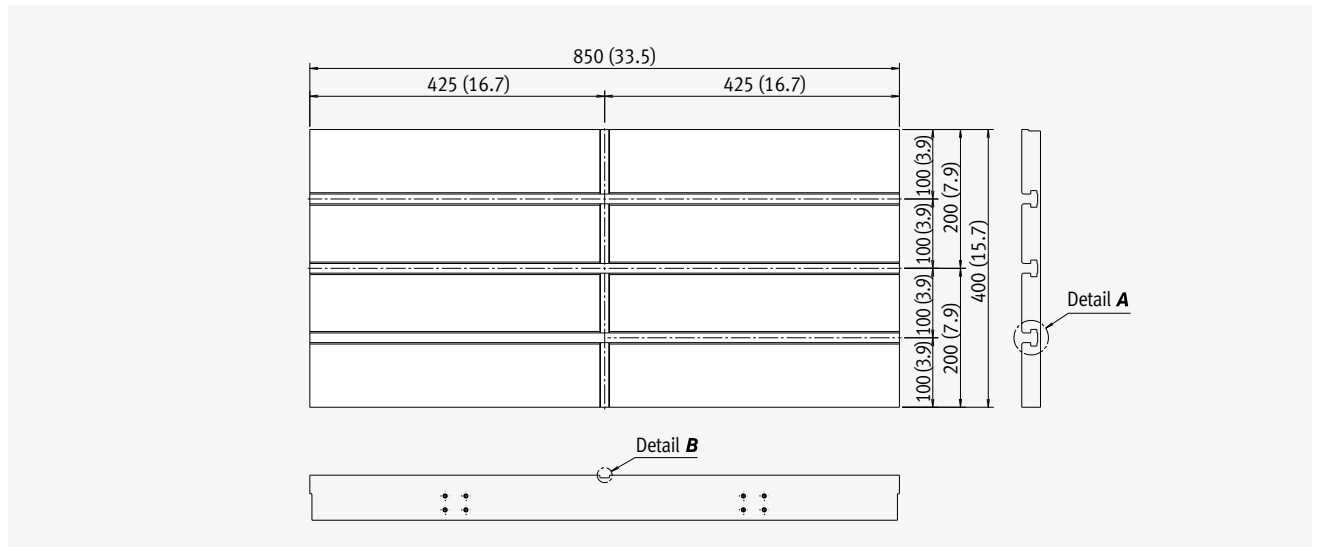

T-slot Specification / Tool Specification

Unit : mm (inch)

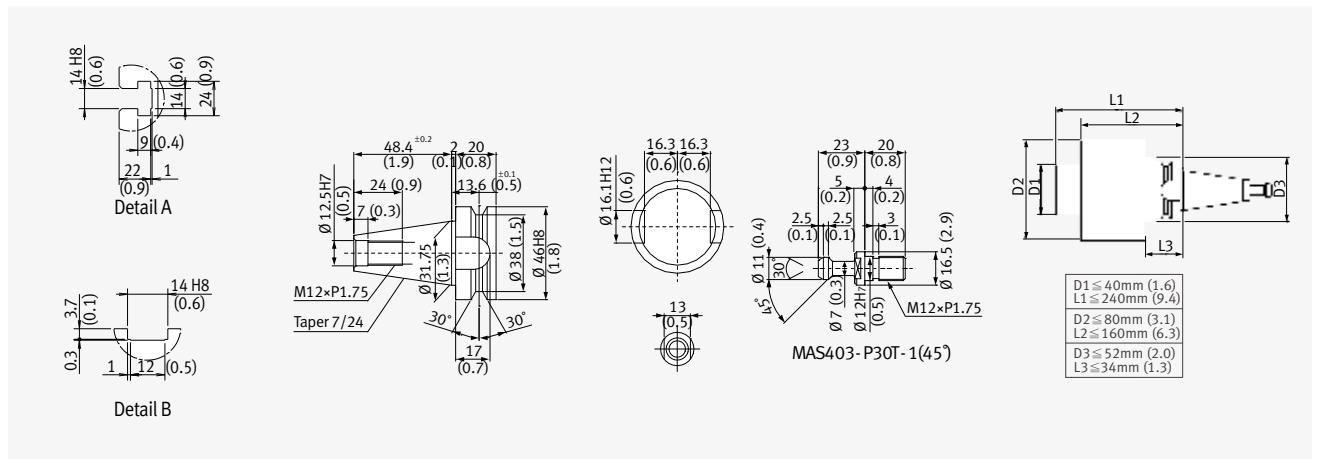

## Machine Specifications



Specification			Unit	T 4000		T 4000L	
				F-0i	F-0i	F-31i	
Travel	Travel distance	X-axis	mm (inch)	520 (20.5)	700 (27.6)		
		Y-axis	mm (inch)	400 (15.7)			
		Z-axis	mm (inch)	350 (13.8)			
	Distance from spindle center to table top		mm (inch)	150 ~ 500 (5.9 ~ 19.7)			
	Distance from spindle center to column		mm (inch)	443 (17.4)			
Feed rate	Rapid Transfer Rate	X-axis	m/min	56	56	48	
		Y-axis	m/min	56	56	48	
		Z-axis	m/min	56	56	48	
	Max. cutting feedrate		m/min	28	28	24	
Table	Table size		mm (inch)	650 X 400 (25.6 X 15.7)	850 X 400 (33.5 X 15.7)		
	Loading capacity		kg (lb)	300 (661.4)			
	Table type			T-SLOT (3-100 X 14H8)			
Spindle	Max. Spindle Speed		r/min	12000 {24000}	12000	24000 {12000}	
	Spindle taper			ISO #30, 7/24 TAPER			
	Max. spindle torque		N-m (ft.-lbs)	82.7 (182.3) (S3 15%) {11.8 (26.0) (5 min)}	82.7 (182.3) (S3 15%)	11.8 (26.0) (5 min) {70 (154.3) (S3 15%)}	
ATC	Tool shank type			MAS403 BT 30 / MAS403 P30T-1 45deg			
	Tool storage capacity		ea	21			
	Max. tool diameter	Continuous	mm (inch)	80 (3.1)			
		Near port empty	mm (inch)	150 (5.9)			
	Max. tool length		mm (inch)	240 (9.4) (Tool diameter ≤ 40 (1.6))			
	Max. tool weight		kg (lb)	2.8 (6.2)			
	Max. tool weight		kg (lb)	33 (72.8)			
	Max. magazine eccentric load weight		kg (lb)	21 (46.3)			
	Tool selection			FIXED ADDRESS			
	Tool change time (tool to tool)		s	1.3	1.3		
Tool change time (chip-to-chip)		s	1.8	1.8*			
Motor	Spindle motor power		kW (Hp)	13 (17.4) (S3 15%) / 7.5 (10.1) (S3 25%) / 5.5 (7.4) (30 min) / 3.7 (5.0) (Cont.) {3.7 (5.0) (5 min) / 2.2 (3.0) (10 min) / 1.1 (1.5) (Cont.)}	13 (17.4) (S3 15%) / 7.5 (10.1) (S3 25%) / 5.5 (7.4) (30min.) / 3.7 (5.0) (Cont.)	3.7 (5.0) (5 min) / 2.2 (3.0) (10 min) / 1.1 (Cont.) {11 (1.5) (S3 15%) / 7.5 (10.1) (S3 25%) / 5.5 (7.4) (30 min) / 3.7 (5.0) (Cont.)}	
	Coolant pump motor power		kW (Hp)	FLOOD : 0.4 (0.5) BASE COOLANT : 0.9 (1.2)			
Power Source	Electric power		kVA	19 {15.7}	19	17.5 {20.8}	
	Power Source		Mpa	0.54			
Dimensions	Height		mm (inch)	2380 (93.7)			
	Length		mm (inch)	2682 (105.6)			
	Width		mm (inch)	1620 (63.8)	2050 (80.7)		
	Weight		kg (lb)	2400 (5291.0)	2500 (5511.5)		

{ } : Optional \* G 100 function applied

# NC Unit Specifications

● Standard ○ Optional ✕ Not applicable



**Basic information**

- Basic Structure
- Cutting
- Performance

**Detailed Information**

- Standard/Optional Specifications
- Applications
- Diagrams
- Machine & NC Unit Specifications

**Customer Support Service**

Item	Spec.	T 4000 / L		
		F-0i	F-31i	
Control Axes	Controlled axes	3 (X, Y, Z)	X, Y, Z	X, Y, Z
	Additional controlled axes	5 axes in total	○	○
	Least command increment	0.001 mm / 0.0001"	●	●
	Least input increment	0.001 mm / 0.0001"	●	●
	Interpolation type pitch error compensation		-	○
Interpolation & Feed Function	2nd reference point return	G30	●	●
	3rd / 4th reference return		●	○
	Inverse time feed		●	○
	Cylindrical interpolation	G07.1	●	○
	Helical interpolation B	Only Fanuc 30i	-	-
	Smooth interpolation		-	○
	NURBS interpolation		-	○
	Involute interpolation		-	○
	Helical involute interpolation		-	○
	Bell-type acceleration/deceleration before look ahead interpolation		○	○
	Smooth backlash compensation		○	●
	Automatic corner override	G62	●	○
	Manual handle feed	Max. 3unit	1 unit	1 unit
	Manual handle feed rate	x1, x10, x100 (per pulse)	●	●
	Handle interruption		●	○
	Manual handle retrace		○	○
	Manual handle feed 2/3 unit		-	○
	Nano smoothing	AI contour control II is required.	○	○
	AI APC	20 BLOCK	●	✕
	AICC I	30 BLOCK	-	✕
	AICC I	40 BLOCK	○	-
	AICC II	200 BLOCK	○	●
	AICC II	400 BLOCK	-	○
	High-speed processing	600 BLOCK	-	○
	Look-ahead blocks expansion	1000 BLOCK	-	○
	DSQ I	AICC II (200block) + Machining condition selection function	-	-
	DSQ II	AICC II (200block) + Machining condition selection function + Data server(1GB)	-	-
DSQ III	AICC II with high speed processing (600block) + Machining condition selection function + Data server(1GB)	-	-	
Spindle & M-code Functions	M- code function		●	●
	Retraction for rigid tapping		●	●
	Rigid tapping	G84, G74	●	●
Tool Function	Number of tool offsets	64 ea	-	64 ea
	Number of tool offsets	99 ea	-	○
	Number of tool offsets	200 ea	-	○
	Number of tool offsets	400 ea	400 ea	○
	Number of tool offsets	499 / 999 / 2000 ea	-	○
	Tool nose radius compensation	G40, G41, G42	●	●
	Tool length compensation	G43, G44, G49	●	●
	Tool life management		●	●
	Addition of tool pairs for tool life management		●	○
	Tool offset	G45 - G48	●	○
Programming and Editing Function	Custom macro		●	●
	Macro executor		○	○
	Extended part program editing		●	●
	Part program storage	256KB(640m)	-	640m
	Part program storage	512KB(1,280m)	1280m	○

Item	Spec.	T 4000 / L		
		F-0i	F-31i	
Programming and Editing Function	Part program storage	1MB(2,560m)	-	○
	Part program storage	2MB(5,120m)	○	○
	Part program storage	4MB(1,0240m)	-	○
	Part program storage	8MB(2,0480m)	-	○
	Inch/metric conversion	G20 / G21	●	●
	Number of Registered programs	400 ea	400 ea	-
	Number of Registered programs	500 ea	-	500 ea
	Number of Registered programs	1000 ea	-	○
	Number of Registered programs	4000 ea	-	○
	Optional block skip	9 BLOCK	●	○
	Optional stop	M01	●	●
	Program file name	32 characters	-	●
	Program number	O4-digits	●	-
	Playback function		●	○
	Addition of workpiece coordinate system	G54.1 P1 - 48 (48 pairs)	48 pairs	48 pairs
	Addition of workpiece coordinate system	G54.1 P1 - 300 (300 pairs)	-	○
OTHERS FUNCTIONS (Operation, setting & Display, etc)	Embedded Ethernet		●	●
	Graphic display	Tool path drawing	●	●
	Loadmeter display		●	●
	Memory card interface		●	●
	USB memory interface	Only Data Read & Write	●	●
	Operation history display		●	●
	DNC operation with memory card		●	●
	Optional angle chamfering / corner R		●	●
	Run hour and part number display		●	●
	High speed skip function		●	○
	Polar coordinate command	G15 / G16	●	○
	Polar coordinate interpolation	G12.1 / G13.1	-	○
	Programmable mirror image	G50.1 / G51.1	●	○
	Scaling	G50, G51	●	○
	Single direction positioning	G60	●	○
	Pattern data input		●	○
	Jerk control	AI contour control II is required.	○	○
	Fast Data server with 1GB PCMCIA card		○	○
	Fast Ethernet		○	○
	3-dimensional coordinate conversion		-	○
	3-dimensional tool compensation		-	○
	Figure copying	G72.1, G72.2	-	○
	Machining time stamp function		-	○
	EZ Guide I with 10.4" Color TFT	Doosan infracore Conversational Programming Solution -When the EZ Guide i is used, the Dynamic graphic display cannot application	○	○
	Dynamic graphic display (with 10.4" Color TFT LCD)	Machining profile drawing. -When the EZ Guide i is used, the Dynamic graphic display cannot application	○	○

# Responding to Customers Anytime, Anywhere

Basic information

- Basic Structure
- Cutting
- Performance

Detailed Information

- Standard/Optional Specifications
- Applications
- Diagrams
- Machine & NC Unit Specifications

Customer Support Service

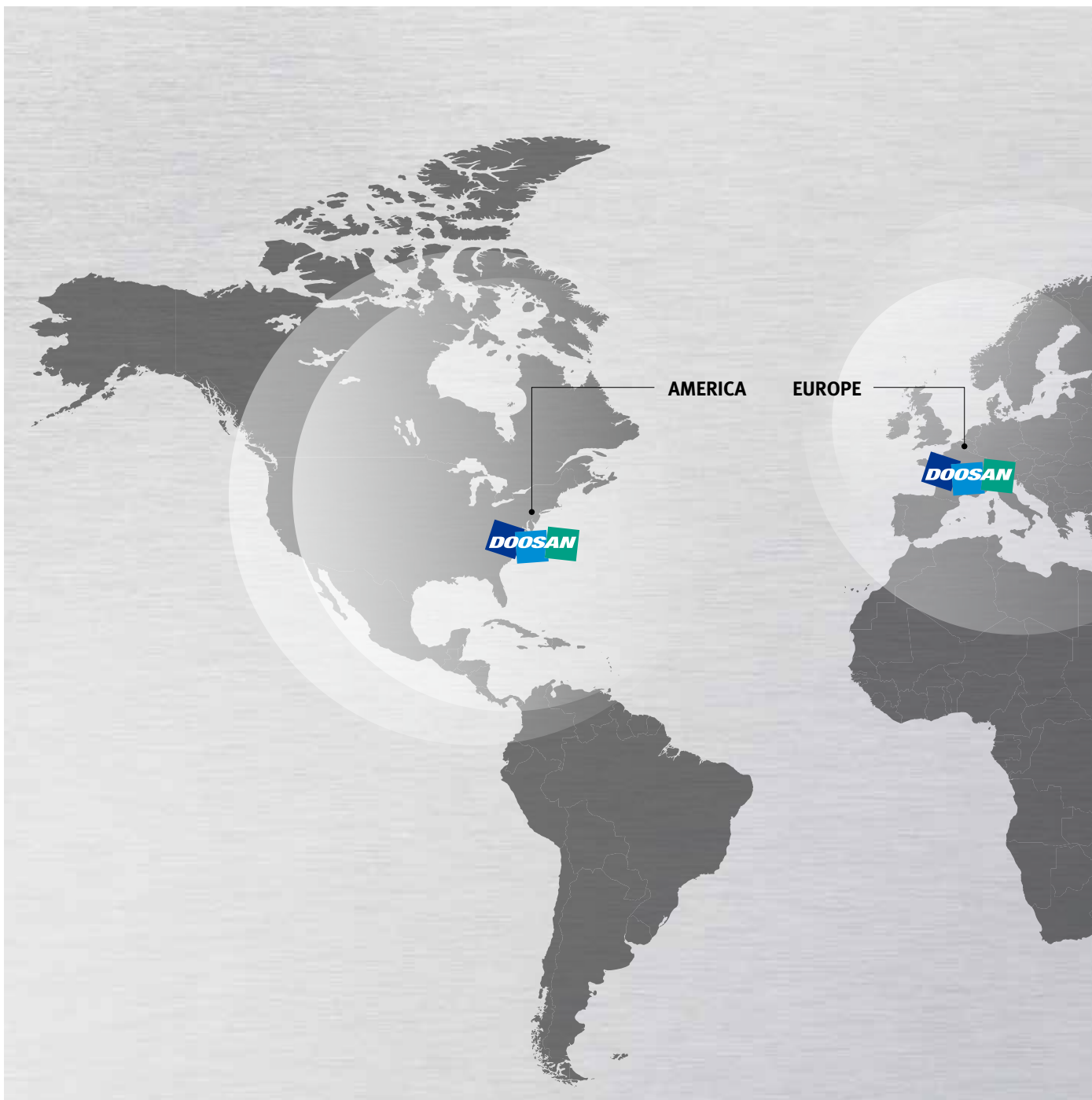

## Global Service Support Network

Corporations

5

Dealer Networks

122

Technical Centers

18

Factories

3

Technical Center: Sales Support, Service Support, Parts Support



**Doosan Machine Tools' Global Network, Responding to Customer's Needs nearby, Anytime, Anywhere**

Doosan machine tools provides a system-based professional support service before and after the machine tool sale by responding quickly and efficiently to customers' demands. By supplying spare parts, product training, field service and technical support, we can provide top class support to our customers around the world.



**Customer Support Service**

We help customers to achieve success by providing a variety of professional services from pre-sales consultancy to post-sales support.

**Supplying Parts**



- Supplying a wide range of original Doosan spare parts
- Parts repair service

**Field Services**



- On site service
- Machine installation and testing
- Scheduled preventive maintenance
- Machine repair

**Technical Support**



- Supports machining methods and technology
- Responds to technical queries
- Provides technical consultancy

**Training**



- Programming / machine setup and operation
- Electrical and mechanical maintenance
- Applications engineering

## T 4000 series



Description	Unit	T 4000	T 4000L
Travel distance (X / Y / Z)	mm (inch)	520 / 400 / 350 (20.5 / 15.7 / 13.8)	700 / 400 / 350 (27.6 / 15.7 / 13.8)
Tool taper	taper	30	30
Table size	mm (inch)	650 x 400 (25.6x15.7)	850 x 400 (33.5x 15.7)
Max. spindle speed	kr/min	12000	12000
Max. spindle motor power	kW (Hp)	13 (17.4)	13 (17.4)
Tool storage capacity	ea	21	21
NC system	-	FANUC	FANUC



## Doosan Machine Tools

<http://www.doosanmachinetools.com>

[www.facebook.com/doosanmachinetools](https://www.facebook.com/doosanmachinetools)

### Optimal Solutions for the Future

#### Head Office

Yeonkang Bldg., 6th FL., 270, Yeonji-dong,  
Jongno-gu, Seoul, Korea  
Tel +82-2-3670-5345 / 5362  
Fax +82-2-3670-5382

#### Doosan Machine Tools China

Room 101,201,301, Building 39 Xinzhuan Highway  
No.258 Songjiang District,China Shanghai(201612)  
Tel +86 21-5445-1155  
Fax +86 21-6405-1472

#### Doosan Machine Tools Japan

#2412, Mita Kokusai Bldg. 1-4-28 Mita,  
Minato-ku, Tokyo 108-0073, Japan  
Tel +81 3 5730 9013  
Fax +81 3 5730 9016

#### Doosan Machine Tools America

19A Chapin Rd., Pine Brook, NJ 07058, U.S.A.  
Tel +1-973-618-2500  
Fax +1-973-618-2501

#### Doosan Machine Tools Europe

Emdener Strasse 24, D-41540 Dormagen, Germany  
Tel +49-2133-5067-100  
Fax +49-2133-5067-111

#### Doosan Machine Tools India

106 / 10-11-12, Amruthahalli, Byatarayanapura,  
Bellary road, Bangalore-560 092, India  
Tel +91-80-4266-0122 / 121 / 100



\* For more details, please contact Doosan Machine Tools.

\* The specifications and information above-mentioned may be changed without prior notice.

\* Doosan Machine Tools Co., Ltd. is a subsidiary of MBK Partners. The trademark  DOOSAN is used under a licensing agreement with Doosan Corporation, the registered trademark holder.